



## COMMERCIAL PRODUCTS

- Roof Hatches
- Automatic Smoke Vents
- Floor Access Doors



**INNOVATIVE ACCESS  
SOLUTIONS, LONG-LASTING  
PERFORMANCE.**

*A Part of Something Bigger<sup>SM</sup>*

**Quanex**



## THE BILCO COMPANY IS NOW PART OF SOMETHING BIGGER

The BILCO Company is now a part of Quanex. Quanex (NYSE: NX), a global, publicly traded manufacturing company serving OEMs in the fenestration, hardware, cabinetry, solar, refrigeration, security, construction, and outdoor products markets. **We are A Part of Something Bigger<sup>SM</sup>.**

We are dedicated to:

- Improving the performance, sustainability and aesthetics of end products through continuous innovation.
- Helping customers achieve greater production efficiencies.
- Giving back to communities where we operate.
- Enhancing shareholder value.
- Helping our employees learn, grow and thrive.

All over the world, from the Dubai skyline to neighborhood homes, Quanex plays a crucial part. We are a community of talented employees working together as one source for quality building components. We're helping to make your end products—and your business—better.

Our solutions include insulating glass spacers, vinyl profiles, window and door screens, hardware, cabinet components, fenestration components, vinyl extrusions, rubber extrusions, kitchen components, bathroom components, millwork, security products, and beyond. One solution at a time, we're striving to build a brighter future for our customers and communities. Globally trusted, driven by innovation, and fueled by technology, we're always thinking about what's next. And we're ready for it.

### Quanex Mission

*To positively impact our customers, employees and shareholders and put them at the center of everything we do, through innovation technology, best-in-class customer service and excellent returns.*

### The BILCO Company

P.O. Box 1203

New Haven, CT 06505

Phone: (800) 366-6530

Fax (203) 535-1582

Email: [commercial@BILCO.com](mailto:commercial@BILCO.com)

Web: [BILCO.com](http://BILCO.com)

The BILCO Company reserves the right to make design changes or to withdraw designs and products shown throughout this catalog without notice as we deem advisable.

©2025 The BILCO Company, New Haven, Connecticut 06505





# Index

## Roof Access Hatches

Ladder Access . . . . .	5
Ship or Steep Stair Access . . . . .	6
Service or Full Service Access . . . . .	7
Equipment Access . . . . .	8-9
Specialty Roof Hatches. . . . .	10-11

## Automatic Smoke Vents

Double Leaf . . . . .	13
Single Leaf . . . . .	14
Natural Daylighting . . . . .	15
Acoustically Sound Rated . . . . .	16

## Safety Products

Bil-Guard® 2.0 Safety Railing System. . . . .	17
LadderUp® Safety Post . . . . .	17

Roofing Product Options . . . . .	18-19
-----------------------------------	-------

## Floor Access Doors

Drainage Frame - Pedestrian Loading . . . . .	20
Drainage Frame - Vehicular Loading. . . . .	22
Non-Drainage Frame - Pedestrian Loading . . . . .	24
Finished Flooring. . . . .	26

Special Application Doors . . . . .	28-31
-------------------------------------	-------

Safety Products. . . . .	32-33
--------------------------	-------

Floor Door Options. . . . .	34
-----------------------------	----

Additional BILCO Products . . . . .	35
-------------------------------------	----

*Product details and specifications are readily available by visiting our download center on BILCO.com.*

## U.S. and International BILCO patents issued:

5,373,665	5,565,274	5,960,596	6,260,305	6,672,020	10,000,944
5,554,433	5,927,012	6,041,553	6,347,818	6,931,793	

*Other U.S. and International patents issued and pending.*





## ROOF ACCESS HATCHES

BILCO roof hatches provide safe and convenient access to roof areas by means of an interior ladder, ship stair or service stair. A variety of special sizes are also available to provide an accessible way to install or remove large pieces of equipment from a building. All products feature engineered lift assistance for easy one-hand operation.



### Benefits

- Easy, one-hand operation
- Weathertight performance
- Energy efficient
- Installs quickly and easily
- Convenient and secure access to roof areas
- Durable construction
- Custom sizes and options readily available

### Features

- Engineered lift assistance
- Heavy-gauge construction
- Positive slam latch with interior and exterior padlock hasps
- Fully insulated and gasketed
- Corrosion resistant hardware
- Bilclip® Flashing System for ease of installation on single-ply roofing
- Available with Miami-Dade County and Florida Product Approval
- Pre-punched capflashing to receive the Bil-Guard® 2.0 Hatch Safety Railing System (see page 17 for more information)







**TYPE S  
TYPE E**

## Ladder Access

The easy one-hand-only operation to the fully opened or closed position provides the user the security of having the other hand firmly on the ladder at all times. Available in galvanized steel, aluminum or stainless steel construction. Aluminum products are also available in a thermally broken design that offers superior energy efficiency and resists condensation.

### Material

- Steel: 14 gauge (1.9mm) galvalume steel
- Aluminum: 11 gauge (2.3mm)
- Stainless Steel: 14 gauge (1.9mm) Type 304 stainless

### Insulation

- 1" (25mm) fiberglass insulation in cover and 1" fiberboard insulation in curb
- 3" (75mm) Polyisocyanurate (R = 20.3) in cover and curb (Thermally Broken Models)

### Finish

- Steel: Alkyd base red oxide primer
- Aluminum: Mil finish
- Stainless Steel: Bead blast finish
- See page 18 for custom finish options

### Hardware

- Zinc plated/chromate sealed
- Type 316 stainless steel



**TYPE S-50TB  
TYPE E-50TB  
THERMALLY BROKEN  
R-20+ INSULATION**

## Specialty Roof Hatches *(see pages 10-11 for more information)*

- Daylighting with polycarbonate skylight
- Retrofit mounting
- Security Series

See pages 18-19 for a complete list of curb, finish and other special options.



Type S-20 and S-50 Only

TYPE	INCHES	MM	MATERIAL	INSULATION	THERMALLY BROKEN
S-20	36 x 30	914 x 762	Steel	1" (25mm)	No
S-50	36 x 30	914 x 762	Aluminum	1" (25mm)	No
S-50TB	36 x 30	914 x 762	Aluminum	3" (75mm)	Yes
S-90	36 x 30	914 x 762	Stainless Steel	1" (25mm)	No
E-20	36 x 36	914 x 914	Steel	1" (25mm)	No
E-50	36 x 36	914 x 914	Aluminum	1" (25mm)	No
E-50TB	36 x 36	914 x 914	Aluminum	3" (75mm)	Yes
E-90	36 x 36	914 x 914	Stainless Steel	1" (25mm)	No

Type S-40 and E-40 models are available in steel curb and aluminum cover.



# ROOF ACCESS HATCHES

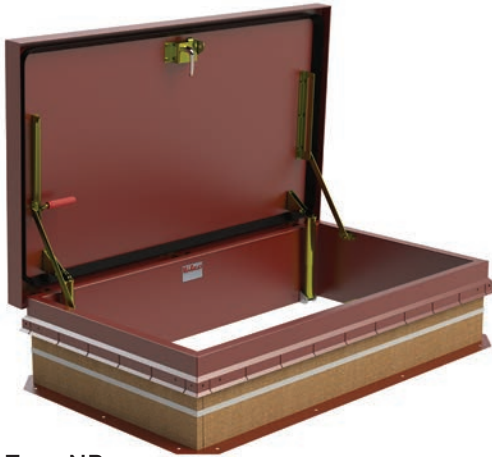

Type NB  
Type NB-HZ

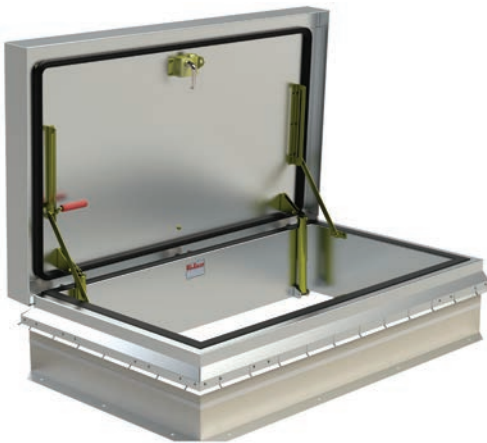

Type NB-50TB  
Thermally Broken  
R-20+ Insulation

## Ship or Steep Stair Access

BILCO Ship Stair access hatches are ideal for installations where frequent use may be expected. Permits easier movement of maintenance personnel, tools, and equipment. Available in galvanized steel, aluminum or stainless steel construction. Aluminum products are also available in a thermally broken design that offers superior energy efficiency and resists condensation.

### Material

- Steel: 14 gauge (1.9mm) galvanized steel
- Aluminum: 11 gauge (2.3mm)
- Stainless Steel: 14 gauge (1.9mm) Type 304 stainless

### Insulation

- 1" (25mm) fiberglass insulation in cover and 1" fiberboard insulation in curb
- 3" (75mm) Polyisocyanurate (R = 20.3) in cover and curb (Thermally Broken Models)

### Finish

- Steel: Alkyd base red oxide primer
- Aluminum: Mil finish
- Stainless Steel: Bead blast finish
- See page 18 for custom finish options

### Hardware

- Zinc plated/chromate sealed
- Type 316 stainless steel

## Specialty Roof Hatches

(see pages 10-11 for more information)

- Daylighting with polycarbonate skylight
- Retrofit mounting
- Security Series

See pages 18-19 for a complete list of curb, finish and other special options.



Type NB-20HZ and NB-50HZ only

TYPE	INCHES	MM	CURB MATERIAL	COVER MATERIAL	INSULATION	THERMALLY BROKEN
NB-20	30 x 54	762 x 1372	Steel	Steel	1" (25mm)	No
NB-20HZ	30 x 54	762 x 1372	Steel	Steel	1" (25mm)	No
NB-50	30 x 54	762 x 1372	Aluminum	Aluminum	1" (25mm)	No
NB-50TB	30 x 54	762 x 1372	Aluminum	Aluminum	3" (75mm)	Yes
NB-50HZ	30 x 54	762 x 1372	Aluminum	Aluminum	1" (25mm)	No
NB-90	30 x 54	762 x 1372	Stainless Steel	Stainless Steel	1" (25mm)	No

Type NB-40 models are available in steel curb and aluminum cover.





Type L



Type L-50TB  
Thermally Broken  
R-20+ Insulation

## Service or Full Service Access

BILCO Service Stair access roof hatches are available in galvanized steel, aluminum or stainless steel construction to meet any job requirements. Aluminum products are also available in a thermally broken design that offers superior energy efficiency and resists condensation.

### Material

- Steel: 14 gauge (1.9mm) galvalume steel
- Aluminum: 11 gauge (2.3mm)
- Stainless Steel: 14 gauge (1.9mm) Type 304 stainless

### Insulation

- 1" (25mm) fiberglass insulation in cover and 1" fiberboard insulation in curb
- 3" (75mm) Polyisocyanurate (R = 20.3) in cover and curb (Thermally Broken Models)

### Finish

- Steel: Alkyd base red oxide primer
- Aluminum: Mil finish
- Stainless Steel: Bead blast finish
- See page 18 for custom finish options

### Hardware

- Zinc plated/chromate sealed
- Type 316 stainless steel

## Specialty Roof Hatches

(see pages 10-11 for more information)

- Daylighting with polycarbonate skylight
- Retrofit mounting
- Security Series

See pages 18-19 for a complete list of curb, finish and other special options.



Type L-20HZ and L-50HZ only

TYPE	INCHES	MM	MATERIAL	INSULATION	THERMALLY BROKEN
L-20	30 x 96	762 x 2438	Steel	1" (25mm)	No
L-50	30 x 96	762 x 2438	Aluminum	1" (25mm)	No
L-50TB	30 x 96	762 x 2438	Aluminum	3" (75mm)	Yes
L-90	30 x 96	762 x 2438	Stainless Steel	1" (25mm)	No

Type L-40 models are available in steel curb and aluminum cover.



## Equipment Access

Larger openings provide an easily accessible means for equipment to be installed or removed from a building. Equipment access roof hatches are available in steel, aluminum and stainless steel construction and in one standard single leaf size [Type F, 48" x 48" (1219mm x 1219mm)]. Special single leaf sizes (Type SS) are available and are recommended for widths up to 5'0" (1524mm). For larger openings, specify double leaf construction (Type D). For best operation, specify aluminum construction for single leaf hatches over 3'0" (914mm) wide and double leaf hatches over 7'0" (2134mm) in width.



### Benefits

- Easy, one-hand operation
- Weathertight performance
- Energy efficient
- Installs quickly and easily
- Convenient and secure access to roof areas
- Durable construction
- Custom sizes and options readily available

### Features

- Engineered lift assistance
- Heavy-gauge construction
- Positive slam latch with interior and exterior padlock hasps
- Fully insulated and gasketed
- Corrosion resistant hardware
- Bilclip® Flashing System for ease of installation on single-ply roofing
- Pre-punched capflashing to receive the Bil-Guard® 2.0 Hatch Safety Railing System (see page 17 for more information)







**Type F**  
48" x 48" (1219mm x 1219mm)  
Custom sizes available

## Product Options

BILCO Equipment access roof hatches are available in galvanized steel, aluminum, stainless steel and copper construction to meet any job requirements.

### Material

- Steel: 14 gauge (1.9mm) galvanized steel
- Aluminum: 11 gauge (2.3mm)
- Stainless Steel: 14 gauge (1.9mm) Type 304

### Insulation

- 1" (25mm) fiberglass insulation in cover and 1" fiberboard insulation in curb
- 3" (75mm) Polyisocyanurate (R = 20.3) in cover and curb (Thermally Broken Models\*)

### Finish

- Steel: Alkyd base red oxide primer
- Aluminum: Mil finish
- Stainless Steel: Bead blast finish
- See page 18 for custom finish options

### Hardware

- Zinc plated/chromate sealed
- Type 316 stainless steel

See pages 18-19 for a complete list of curb, finish and other special options.

*\*Thermally broken models are not available in double leaf design*



**Type F-50TB**  
48" x 48" (1219mm x 1219mm)  
Thermally Broken  
R-20+ Insulation  
Custom sizes available



Type F-50HZ only



**Type D**  
Special Size



## Specialty Roof Hatches

BILCO also has a long history of providing specialty access solutions for virtually any application. Whether for extreme environments, secure facilities, retrofit applications or day-lighting, there is a BILCO roof hatch ready to do the job. Along with an extensive array of available roof hatch options (see pages 18-19), BILCO also offers custom-engineering capabilities to ensure safe and reliable roof access no matter what the application.

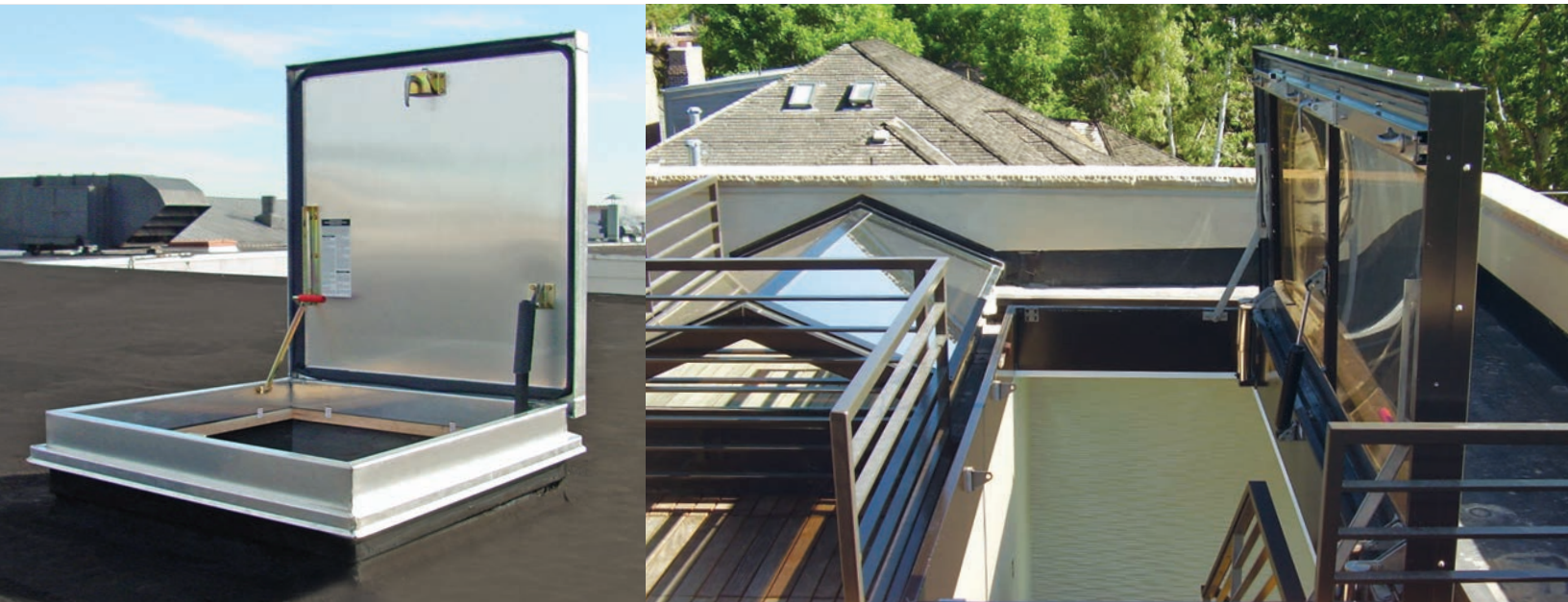

### Benefits

- Easy, one-hand operation
- Weathertight performance
- Energy efficient
- Installs quickly and easily
- Convenient and secure access to roof areas
- Durable construction
- Custom sizes and options readily available

### Features

- Engineered lift assistance
- Heavy-gauge construction
- Positive slam latch with interior and exterior padlock hasps
- Fully insulated and gasketed
- Corrosion resistant hardware
- Bilclip® Flashing System for ease of installation on single-ply roofing
- Pre-punched capflashing to receive the Bil-Guard® 2.0 Hatch Safety Railing System (see page 17 for more information)

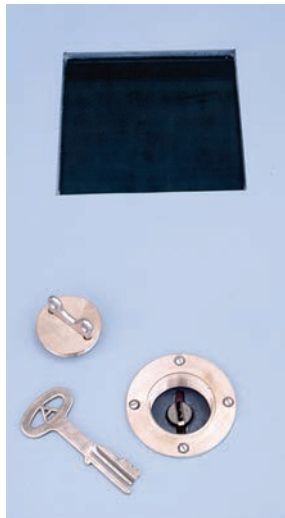



## Type GS Daylighting Roof Hatch

All the security and convenience of the Type S roof hatch with the added benefits of a skylight. GS Roof Hatches feature aluminum construction and virtually indestructible polycarbonate domes. Domes are available in clear and translucent and double domes can be specified. Specify Type GSS for custom single leaf sizes.



## Security Series Roof Hatch

Constructed of heavier gauge materials for high security applications such as prisons, banks, embassies, and pharmaceutical buildings. Roof hatches can be fabricated for field installation of many leading brands of security locks. Other options include security glazing and gunports (see page 19).

## VersaMount® Retrofit Roof Hatch

The VersaMount® replacement hatch allows you to replace a damaged roof hatch without re-roofing. Simply remove the cover from the damaged hatch and place the VersaMount® hatch on top of the existing curb. The low-profile curb features a built-in flange and apron and innovative anchor clip system to ensure a fast, secure and weathertight installation. Available in a number of standard sizes.

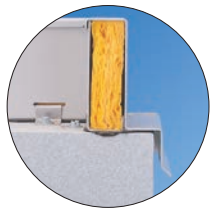

Job-Built  
Concrete Curbs



Existing Roof Hatch  
or Job-Built/Prefab  
Metal Curbs



Job-Built  
Wood Curbs





## Automatic Smoke Vents

Automatic Smoke Vents protect property and aid firefighters in bringing a fire under control by removing smoke, heat, and gases from a burning building. Ideally suited for large expanses of unobstructed space such as factories, warehouses, auditoriums, and retail facilities smoke vents are available in a number of standard UL-listed sizes.



### Benefits

- Increased evacuation time and decreased risk of smoke inhalation and damage
- Enhanced visibility to allow firefighters to quickly locate the fire
- Protection against secondary ignitions and lateral fire spread
- Exhausting of noxious and potentially explosive fumes
- Structure protection from damaging heat
- Reduced damage to building contents

### Features

- Fully insulated and gasketed for weathertight performance.
- Thermolatch® II latching mechanism with curb mounted fusible link housing for quick and easy resetting at the roof level
- Exterior and interior pull release handles for manual operation
- Covers open against a 10 psf (49 kg/m<sup>2</sup>) snow/wind load and automatically lock in the open position upon vent activation
- Bilclip® Flashing System for ease of installation on single-ply roofing
- Pre-punched capflashing to receive the Bil-Guard® 2.0 Hatch Safety Railing System (see page 17 for more information)
- Complies with UL790 Class A and UL793
- Available in a number of UL-approved sizes



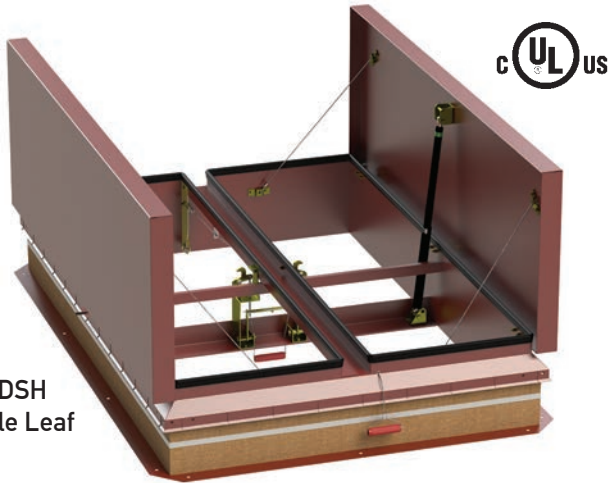

Type DSH  
Double Leaf

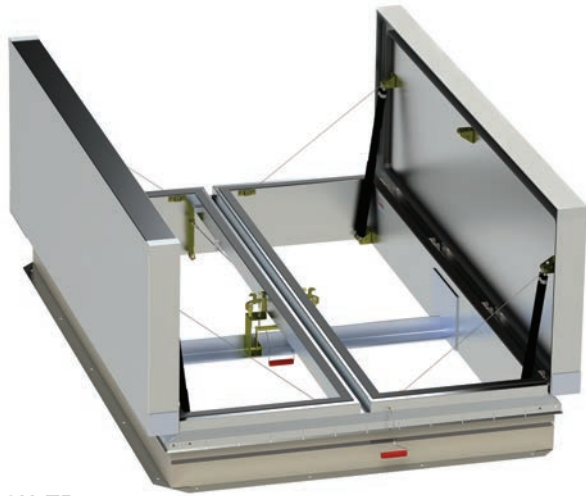

Type DSH-TB  
60" x 96" (1524mm x 2438mm)  
Thermally Broken  
R-20+ Insulation  
Custom sizes available

## Double Leaf

BILCO smoke vents feature a positive hold/release mechanism controlled by a single UL-listed 165°F (74°C) fusible link designed to hold the covers closed against a 90 psf (438 kg/m<sup>2</sup>) wind uplift force. Smoke vents are provided with interior and exterior pull release cables to manually open vent covers. Aluminum products are also available in a thermally broken design that offers superior energy efficiency and resists condensation.

### Material

- Steel: 14 gauge (1.9mm) galvanized steel
- Aluminum: 11 gauge (2.3mm) aluminum

### Insulation

- 1" (25mm) fiberglass insulation in cover and 1" fiberboard insulation in curb
- 3" (75mm) Polyisocyanurate (R = 20.3) in cover and curb (Thermally Broken Models)

### Finish

- Alkyd base red oxide primer (standard on all steel products)
- Mil finish (standard on all aluminum products)
- See page 18 for custom finish options

### Hardware

- Zinc plated/chromate sealed hardware

### Control Options

- Motor operation with push button control station
- Winch operation for remote opening and closing
- Electric release for smoke detector or fire alarm activation
- See page 19 for more information

## Type DSH Standard Sizes

INCHES	MM	STEEL	STEEL CURB, ALUMINUM COVER	ALUMINUM
48 x 48	1219 x 1219	DSH4848	DSH4848A	DSH4848B
48 x 72	1219 x 1829	DSH4872	DSH4872A	DSH4872B
48 x 90	1219 x 2286	DSH4890	DSH4890A	DSH4890B
48 x 96	1219 x 2438	DSH4896	DSH4896A	DSH4896B
60 x 60	1524 x 1524	DSH6060	DSH6060A	DSH6060B
60 x 72	1524 x 1829	DSH6072	DSH6072A	DSH6072B
60 x 84	1524 x 2134	DSH6084	DSH6084A	DSH6084B
60 x 96	1524 x 2438	DSH6096	DSH6096A	DSH6096B
60 x 120	1524 x 3048	DSH60120	DSH60120A	DSH60120B
66 x 66	1676 x 1676	DSH6666	DSH6666A	DSH6666B
66 x 144	1676 x 3658	DSH66144*	DSH66144A*	DSH66144B*
72 x 72	1829 x 1829	DSH7272	DSH7272A	DSH7272B

\*This size has four leaves.



# AUTOMATIC SMOKE VENTS

## Single Leaf

BILCO smoke vents feature a positive hold/release mechanism controlled by a single UL-listed 165°F (74°C) fusible link designed to hold the covers closed against a 90 psf (438 kg/m<sup>2</sup>) wind uplift force. Smoke vents are provided with interior and exterior pull release cables to manually open vent covers. Aluminum products are also available in a thermally broken design that offers superior energy efficiency and resists condensation.

### Material

- Steel: 14 gauge (1.9mm) galvanized steel
- Aluminum: 11 gauge (2.3mm) aluminum

### Insulation

- 1" (25mm) fiberglass insulation in cover and 1" fiberboard insulation in curb

### Finish

- Alkyd base red oxide primer (standard on all steel products)
- Mil finish (standard on all aluminum products)
- See page 18 for custom finish options

### Hardware

- Zinc plated/chromate sealed hardware

### Control Options

- Motor operation with push button control station
- Winch operation for remote opening and closing
- Electric release for smoke detector or fire alarm activation
- See page 19 for more information



**Type S-SV**  
 Single Leaf  
 36" x 30"  
 (914mm X 762mm)  
 Custom sizes available



**Type S-50SVTB**  
 36" x 30"  
 (914mm x 762mm)

**Type H-50SVTB**  
 48" x 60"  
 (1219mm x 1524mm)

**Thermally Broken**  
 R-20+ Insulation  
 Custom sizes available



## Natural Daylighting

Offers the same benefits as BILCO Automatic Smoke Vents with a built-in skylight for natural daylighting and to reduce energy costs. Featuring a polycarbonate cover design that resists UV degradation and offers superior insulation performance compared to traditional domes. The sloped or domed cover designs meet International Building Code Requirements.

### Material

- Aluminum: 11 gauge (2.3mm) aluminum

### Cover

- Single Leaf: clear polycarbonate dome or double domes
- Double leaf: Translucent multi-wall polycarbonate

### Finish

- Mil finish (standard on all aluminum products)
- See page 18 for custom finish options

### Hardware

- Stainless steel hinges and zinc plated/chromate sealed hardware



### Type GS-SV

Single Leaf  
36" X 30" (914mm x 762mm)  
Custom sizes available



Lumivent®  
Double Leaf

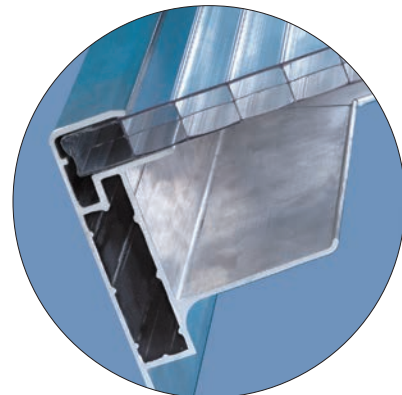

*Features a multi-wall polycarbonate cover design that resists UV degradation and offers superior insulation performance compared to traditional domes*

## Lumivent Standard Sizes

TYPE	INCHES	MM	MATERIAL
LV4848B	48 x 48	1219 x 1219	Aluminum
LV4872B	48 x 72	1219 x 1829	Aluminum
LV4896B	48 x 96	1219 x 2438	Aluminum
LV6060B	60 x 60	1524 x 1524	Aluminum
LV6096B	60 x 96	1524 x 2438	Aluminum
LV66144B	66 x 144	1676 x 3658	Aluminum





# AUTOMATIC SMOKE VENTS

## Acoustically Sound Rated

BILCO's ACDSV acoustical smoke vent is designed to guard against noise intrusion while providing the security of automatic smoke venting. Acoustical vents feature industry-high OITC-46 and STC-50 sound ratings. They are ideal for concert halls, theaters and other interior applications that require limited noise from the outside. Vents are available in steel construction and in a number of UL-Listed standard sizes.

### Material

- Steel: 14 gauge (1.9mm) galvalneal steel

### Insulation

- 4" (100 mm) mineral wool insulation

### Finish

- Alkyd base red oxide primer
- See page 18 for custom finish options

### Hardware

- Zinc plated/chromate sealed hardware

### Control Options

- Motor operation with push button control station
- Winch operation for remote opening and closing
- Electric release for smoke detector or fire alarm activation
- See page 19 for more information

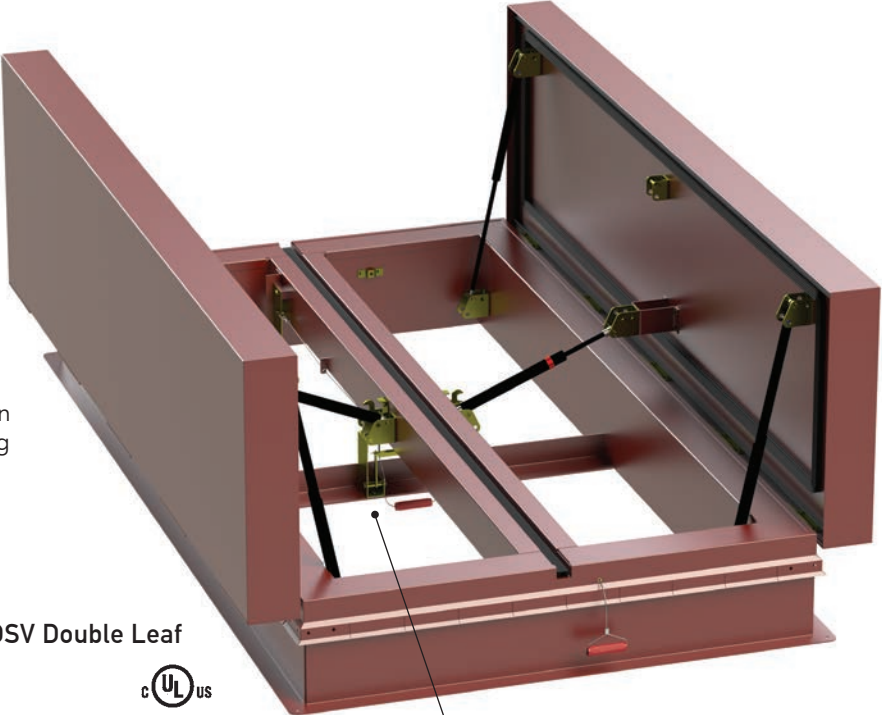

Type ACDSV Double Leaf



**Sound Ratings**  
 OITC-46  
 STC-50  
 ISO 140-18 (rain fall)

TYPE	INCHES	MM
ACDSV4848	48 x 48	1219 x 1219
ACDSV4896	48 x 96	1219 x 2438
ACDSV6096	60 x 96	1524x 2438
ACDSV66144	66 x 144*	1676 x 3658
ACDSV 7272	72 x 72	1829 x 1829

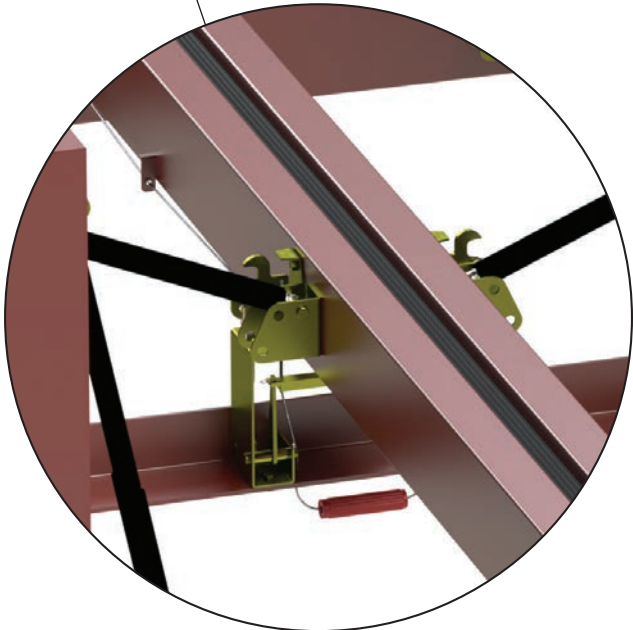

*Thermolatch® II latching mechanism with curb mounted fusible link housing for quick and easy resetting at the roof level.*

## SAFETY PRODUCTS



### Bil-Guard® 2.0 Safety Railing System

Bil-Guard® 2.0 is a fixed railing system that provides a permanent means of fall protection for hatch openings. Tested and proven to meet and exceed OSHA fall protection standards (29 CFR 1910.29), Bil-Guard® 2.0 features an innovative attachment system that does not penetrate the roofing membrane, installs quickly and easily using basic tools, and does not require special training or certification for proper installation. Corrosion-resistant aluminum rails and mounting brackets, along with stainless steel hardware, are ideal for any climate.

ROOF HATCH SIZE (width x length)		ROOF HATCH MODEL	BIL-GUARD 2.0 MODEL
INCHES	MM		
36 x 30	914 x 762	S	RL2-S
36 x 36	914 x 914	E	RL2-E
48 x 48	1219 x 1219	F	RL2-F
30 x 54	762 x 1372	NB	RL2-NB
30 x 96	762 x 2438	L	RL2-L

*Railing system models available for thermally broken and custom size roof hatches and automatic smoke vents.*



### LadderUP® Safety Post

LadderUP® Safety Posts provide easier, safer ladder access through roof hatches, floor access doors and manholes. This telescoping post permanently mounts to the top two rungs of any fixed ladder, providing a positive hand-hold and enabling the user to enter or exit an opening in an upright and balanced position. The adjustable mounting hardware accommodates virtually any ladder rung size or spacing.

MODEL#	MATERIAL/FINISH	WEIGHT	
		LBS.	KG.
LU-1	Steel, yellow powder coat	24	11
LU-2	Steel, hot dip galvanized	24	11
LU-3	Type 304 Stainless Steel, sand blast finish	24	11
LU-4	Aluminum, mill finish	14	7

\* This size has four leafs



## ROOFING PRODUCT OPTIONS



Stainless Steel Hardware

### Common Options

#### Stainless Steel Hardware

For installation in highly corrosive environments, Bilco smoke vents and roof hatches may be equipped with Type 316 stainless steel hardware, including: slam latch and lifting mechanism assemblies; hold-open and guide arms; and all brackets, hinges, pins, and fasteners.

#### Curb Options

All BILCO roofing products may be specified with either a curb liner (metal insulation liner of the same materials as the curb and capflashing) or a fully enclosed curb (full metal insulation liner of the same materials as the curb, which replaces the capflashing). Built-in louvers are available for roof hatches and for automatic smoke vents to meet elevator-shaft code requirements. Base flanges can be supplied with configurations for most brands of metal building roof panels. This option offers simplified installation, and includes a built-in self-drainage feature that eliminates water accumulation on the up-slope side.



Curb Modification for Metal Buildings

#### Insulation

BILCO offers insulation options to enhance the energy efficiency of its roofing products. Standard roof products are supplied with standard 1" (25mm) fiberglass insulation in the covers and 1" (25mm) fiberboard insulation in the curb. When specified, products can be supplied with up to 2" (50mm) of Styrofoam or polyisocyanurate insulation in the cover and curb. Roof hatches and smoke vents can also be supplied in a thermally broken design that features 3" (75mm) of polyisocyanurate insulation in the cover and curb.

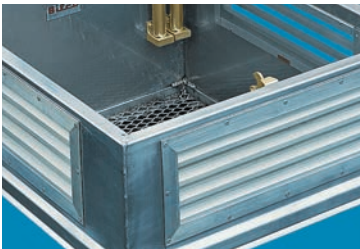

Built-in Louvers

#### Special Finishes

- Factory applied powder coat paint finish is available on all steel and aluminum products. Finish is available in four standard colors and custom colors can be specified.
- Kynar® finish in custom colors (aluminum products only)
- Tnemec® finish in custom colors (steel and aluminum products)
- Clear anodized finish (aluminum products only)
- Custom finishes can also be specified

### Powder Coat Standard Colors (Custom colors can also be specified)



White



Yellow



Bronze



Black



Winch Operation

#### Motorized or Winch Operation

To provide a convenient means of ventilating work areas, automatic smoke vents can be equipped with motor operators for actuation by remote push-button control or other electrical signal. They can also be furnished with rigging for manual winch operation at the floor level. Roof hatches can also be designed for motor or winch operation.

#### Other Options

In addition to standard options, BILCO's custom engineering capabilities can provide you with the exact roof product to meet your unique requirements.

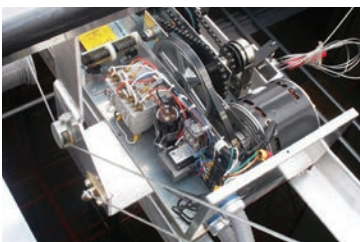

Motorized Operation





Keyed Cylinder Locks



Detention Locks

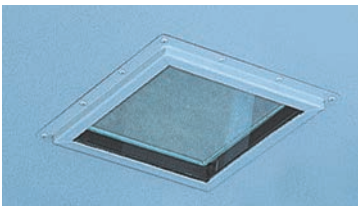

Security Glazing



Electric Activation



Explosion Vents

## Roof Hatch Options

### Security

All BILCO roof hatches are supplied with a standard slam lock that includes an interior and exterior padlock hasp to prevent unauthorized access. BILCO also offers the options listed below for enhanced building security.

### Keyed Cylinder Locks

Deadbolt cylinder locks provide keyed exterior access and are available with either keyed or turn knob interior access. Cylinder locks are an ideal security enhancement for many applications. For added security and weathertightness, the lock cylinder is accessed from the exterior through a gasketed, threaded deck plate.

### Detention Locks

Detention locks provide keyed interior and exterior access and are ideal for correctional facilities and other buildings requiring a maximum level of security. For added security and weathertightness, the lock is accessed from the exterior through a gasketed, threaded deck plate. BILCO roof hatches can be prepared for field installation of many leading lock brands.

### Emergency Egress Locks

BILCO roof hatches can be supplied with a panic lock for rapid egress in an emergency situation. Panic locks are available with keyed exterior access when specified.

### Indicator Switches

Allow roof hatches to be wired into a building's alarm system. Indicator switches are curb mounted and send a signal to the alarm control panel when the hatch cover is opened.

### Security Glazing

Security glazing allows personnel to visibly scan a secure area before entering or exiting a roof area. Glazing is available in a number of ballistic ratings with varying levels of security.

## Smoke Vent Options

### Electric Activation

Automatic smoke vents can be supplied with an electric Thermolatch® to allow the vents to be operated by a smoke detector or fire alarm control panel. In addition to electric activation, these vents feature fusible link activation and provisions for manual operation. Electric latches can be supplied for 115 VAC, 24 VAC, 220 VAC, and 24V DC power requirements.

### Security Grilles

Heavy bars permanently welded in place across the curb opening. Bars are spaced to prevent building access and maximize ventilation area.

### Explosion Vents

BILCO Type SV and Type DSH automatic smoke vents may also be equipped to operate as explosion vents or as combination fire/explosion vents. The explosion release mechanism is preset and factory-tested to release at between 25 lb/ft<sup>2</sup> and 30 lb/ft<sup>2</sup> – 122 kg/m<sup>2</sup> and 146 kg/m<sup>2</sup> of pressure on the underside of the covers. Not available on Type ACDSH or Lumivent models.

### Lockable Enclosures

The exterior manual pull release may be supplied with an enclosure that can be padlocked to prevent unauthorized opening of the covers from the roof level.

### Indicator Switches

Allow vents to be wired into a building's alarm system. Indicator switches are curb mounted and send a signal to the alarm control panel when the vent covers are opened.



## Drainage Frame – Pedestrian Loading

Designed for exterior or other fluid prevalent applications, BILCO channel frame floor doors provide reliable access to equipment stored underground or below/between building floors. Available in a wide range of standard sizes and in single- or double-leaf formats, all BILCO floor access doors feature heavy-duty construction and positive latching mechanisms to help prevent unauthorized access.



### Benefits

- Convenient access to underground areas
- Allows for easy inspection of utilities, pumps, and other underground equipment
- Smooth, easy, one-hand operation
- Rugged construction is designed for many years of trouble-free service

### Features

- Threaded, fully welded drain coupling assures liquid flow management
- Engineered lift assistance for smooth, easy, one-hand operation
- Automatic hold-open arm with convenient release handle securely locks the cover in the open position
- Full welded and reinforced construction
- Positive stainless steel latching mechanism and corrosion resistant hardware





**Aluminum**  
 Type J-AL - Single Leaf  
 Type JD-AL - Double Leaf



**Steel**  
 Type J - Single Leaf  
 Type JD - Double Leaf

## Pedestrian Loading

Single or double leaf covers are constructed of 1/4" (6.35mm) diamond pattern plate and reinforced for a 300 psf (1464 kg/m<sup>2</sup>) live load. Features include heavy-duty construction, standard Type 316 stainless steel slam lock and fasteners, and a built-in concrete anchoring system for ease of installation.

### Cover and Frame Material

- Steel: 1/4" (6.35 mm)
- Aluminum: 1/4" (6.35 mm)

### Finish

- Steel: Alkyd base red oxide primer
- Aluminum: Mill Finish with a bituminous coating on frame exterior
- See page 34 for custom finish options

### Hardware

- Steel: Zinc plated and chromate sealed compression spring tubes. Type 316 stainless steel hinges and fasteners.
- Aluminum: Type 316 stainless steel

### Warranty

- Steel: 5-years
- Aluminum: 25-years

### Other Options

- Keyed Cylinder Locks
- Grating covers
- Custom sizes

See page 34 for more information and a complete list of options.

INCHES	MM	STEEL	ALUMINUM
24 x 24	610 x 610	J-1	J-1AL
30 x 30	762 x 762	J-2	J-2AL
36 x 30	914 x 762	J-3	J-3AL
36 x 36	914 x 914	J-4	J-4AL
42 x 42	1067 x 1067	J-5	J-5AL
30 x 48	762 x 1219	J-6	J-6AL
36 x 48	914 x 1219	J-7	J-7AL
30 x 60	762 x 1524	J-8	J-8AL
36 x 60	914 x 1524	J-9	J-9AL
36 x 72	914 x 1829	J-10	J-10AL
48 x 30	1219 x 762	JD-1	JD-1AL
48 x 48	1219 x 1219	JD-2	JD-2AL
48 x 72	1219 x 1829	JD-3	JD-3AL
60 x 60	1524 x 1524	JD-4	JD-4AL

\*Types with "D" in the Type # indicate a double leaf configuration.



## Drainage Frame – Vehicular Loading

Designed for exterior or other fluid-prevalent applications subjected to vehicular traffic, BILCO channel frame H20 floor doors provide reliable access to equipment stored underground while meeting AASHTO H-20 wheel loading requirements. Available in a wide range of standard sizes and in single- or double-leaf formats, all BILCO H20 doors feature heavy-duty construction and positive latching mechanisms to help prevent unauthorized access.

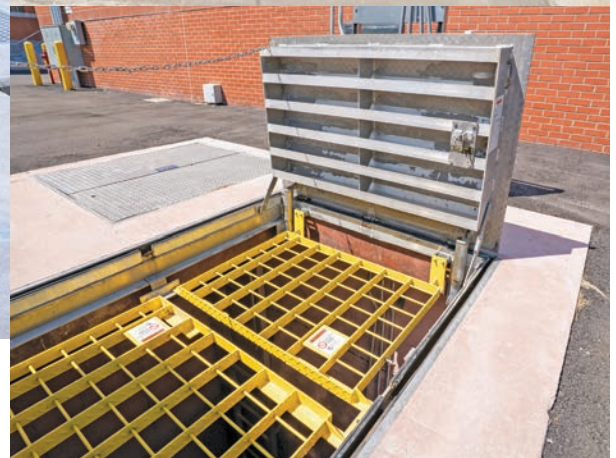

### Benefits

- Convenient access to underground areas
- Allows for easy inspection on utilities, pumps, and other underground equipment
- Smooth, easy, one-hand operation
- Rugged construction is designed for many years of trouble-free service

### Features

- Threaded, fully welded drain coupling assures liquid flow management
- Engineered lift assistance for smooth, easy, one-hand operation
- Automatic hold-open arm with convenient release handle securely locks the cover in the open position
- Full welded and reinforced construction for AASHTO H20 wheel loading
- Positive stainless steel latching mechanism and corrosion resistant hardware





**Aluminum**

Type J-AL - Single Leaf  
 Type JD-AL - Double Leaf



**Steel**

Type J H20 - Single Leaf  
 Type JD H20 - Double Leaf

Note: Designed to withstand an H-20 wheel loading and suitable for use in off-street locations where not subjected to high-density traffic.

**Vehicular Loading**

Single or double leaf covers are constructed of 1/4" (6.35mm) diamond pattern plate and reinforced for a AASHTO H-20 wheel loading. Features include heavy-duty construction, standard Type 316 stainless steel slam lock and fasteners, and a built-in concrete anchoring system for ease of installation.

**Cover and Frame Material**

- Steel: 1/4" (6.35 mm)
- Aluminum: 1/4" (6.35 mm)

**Finish**

- Steel: Alkyd base red oxide primer
- Aluminum: Mill Finish with a bituminous coating on frame exterior
- See page 34 for custom finish options

**Hardware**

- Steel: Zinc plated and chromate sealed compression spring tubes. Type 316 stainless steel hinges and fasteners.
- Aluminum: Type 316 stainless steel

**Warranty**

- Steel: 5-years
- Aluminum: 25-years

**Other Options**

- Keyed Cylinder Locks
- Grating covers
- Custom sizes

See page 34 for more information and a complete list of options.

INCHES	MM	STEEL	ALUMINUM
24 x 24	610 x 610	J-1	J-1AL
30 x30	762 x 762	J-2	J-2AL
36 x 30	914 x 762	J-3	J-3AL
36 x 36	914 x 914	J-4	J-4AL
42 x 42	1067 x 1067	J-5	J-5AL
30 x 48	762 x 1219	J-6	J-6AL
36 x 48	914 x 1219	J-7	J-7AL
30 x 60	762 x 1524	J-8	J-8AL
36 x 60	914 x 1524	J-9	J-9AL
36 x 72	914 x 1829	J-10	J-10AL
48 x 30	1219 x 762	JD-1	JD-1AL
48 x 48	1219 x 1219	JD-2	JD-2AL
48 x 72	1219 x 1829	JD-3	JD-3AL
60 x 60	1524 x 1524	JD-4	JD-4AL

\*Types with "D" in the Type # indicate a double leaf configuration.



## Non-Drainage Frame – Pedestrian Loading

Designed for interior use or exterior applications where water or liquid infiltration into the access opening is not a concern. BILCO angle frame floor access doors provide 150 PSF reinforcing for pedestrian applications and engineered lift assistance for easy one-hand operation. Available in a number of standard single leaf and double leaf sizes and special sizes can be specified to meet unique access requirements.



### Benefits

- Convenient access to underground areas
- Allows for easy inspection on utilities, pumps, and other underground equipment
- Smooth, easy, one-hand operation
- Rugged construction is designed for many years of trouble-free service

### Features

- Engineered lift assistance for smooth, easy, one-hand operation
- Automatic hold-open arm with convenient release handle securely locks the cover in the open position
- Full welded and reinforced construction
- Positive stainless steel latching mechanism and corrosion resistant hardware



## Pedestrian Loading

Single or double leaf covers are constructed of 1/4" (6.35mm) diamond pattern plate and reinforced for a 150 psf (732 kg/m<sup>2</sup>) live load. Features include standard zinc plated/chromate sealed hardware and a versatile anchoring system for ease of installation.

### Cover and Frame Material

- Steel: 1/4" (6.35 mm)
- Aluminum: 1/4" (6.35 mm)

### Finish

- Steel: Alkyd base red oxide primer
- Aluminum: Mill Finish with a bituminous coating on frame exterior
- See page 34 for custom finish options

### Hardware

- Type 316 stainless steel slam lock and zinc plated/chromate sealed hardware

### Warranty

- 5-years

### Other Options

- Keyed Cylinder Locks
- Grating covers
- Custom sizes

See page 34 for more information and a complete list of options.



### Aluminum

Type K - Single Leaf  
Type KD - Double Leaf



INCHES	MM	STEEL	ALUMINUM
24 x 24	610 x 610	Q-1	K-1
30 x 30	762 x 762	Q-2	K-2
36 x 30	914 x 762	Q-3*	K-3
36 x 36	914 x 914	Q-4	K-4
42 x 42	1067 x 1067	--	K-5
48 x 48	1219 x 1219	--	KD-2
48 x 72	1219 x 1819	--	KD-3
60 x 60	1524 x 1524	--	KD-4

\*The Q-3 model is hinged on the 36" side.

### Steel

Type Q - Single Leaf  
Double Leaf not available



## For Finished Flooring

BILCO's floor access doors allow design professionals to provide concealed access in decorative flooring materials. The unique cover designs will accept a wide variety of architectural materials, allowing the doors to be used in virtually any application. Whether it's carpet, tile, hardwood, or even granite, each door is precisely engineered with lift assistance to afford the user with easy, one-hand operation.



### Benefits

- Concealed access to underground areas
- Smooth, easy, one-hand operation
- Rugged construction is designed for many years of trouble-free service

### Features

- Unique cover designs accept flooring materials
- Engineered lift assistance for smooth, easy, one-hand operation
- Automatic hold-open arm with convenient release handle securely locks the cover in the open position
- Full welded and reinforced construction
- Positive stainless steel latching mechanism and corrosion resistant hardware

## Finished Flooring

Single or double leaf covers are constructed of 1/4" (6.35mm) plate and reinforced for a 150 psf (732 kg/m<sup>2</sup>) live load. Features include a versatile anchoring system for ease of installation.

### Cover and Frame Material

- 1/4" (6.35 mm) Aluminum

### Cover

- Type T & TD: Will accept carpet or composition flooring material 1/8" (3.18mm) or 3/16" (4.76mm) in thickness. Features cover and frame mounted molding strips to accept floor covering.
- Type TER & TRD: Designed with a pan cover to accept a variety of flooring materials up to 1" (25.4mm) in thickness. Each door is spring balanced at the factory to ensure smooth, easy operation upon installation of the specified flooring material in the field.

### Finish

- Mill Finish with a bituminous coating on frame exterior

### Hardware

- Zinc plated and chromate sealed
- Type 316 stainless steel

### Warranty

- 5-years

### Other Options

- Keyed Cylinder Locks
- Custom sizes

See page 34 for more information and a complete list of options.

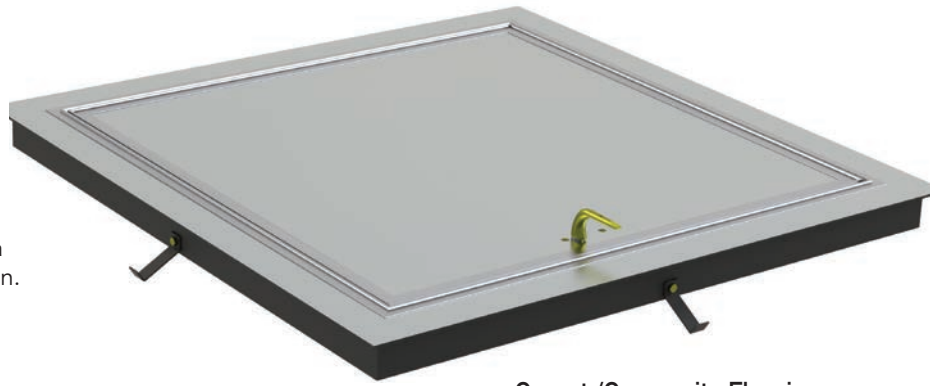

### Carpet /Composite Flooring

Type T - Single Leaf  
Type TD - Double Leaf

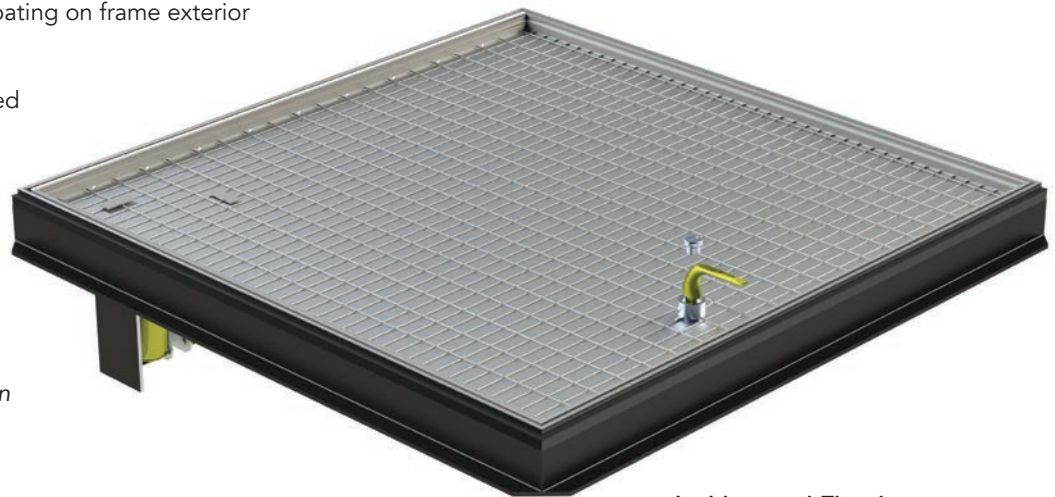

### Architectural Flooring

Type TER - Single Leaf  
Type TRD - Double Leaf

INCHES	MM	SMOOTH PLATE	FILLABLE PAN
24 x 24	610 x 610	T-1	TER-1
30 x30	762 x 762	T-2	TER-2
36 x 30	914 x 762	T-3	TER-3
36 x 36	914 x 914	T-4	TER-4
42 x 42	1067 x 1067	T-5	TER-5
48 x 48	1219 x 1219	TD-2	TRD-2
48 x 72	1219 x 1829	TD-3	TRD-3
60 x 60	1524 x 1524	TD-4	TRD-4

\*Types with "D" in the Type # indicate a double leaf configuration.





## SPECIAL APPLICATION DOORS

BILCO is the world leader in the design and manufacture of floor access doors for special applications. In addition to the doors shown on the following pages, our engineering staff can custom design products to meet the access requirements for virtually any application.

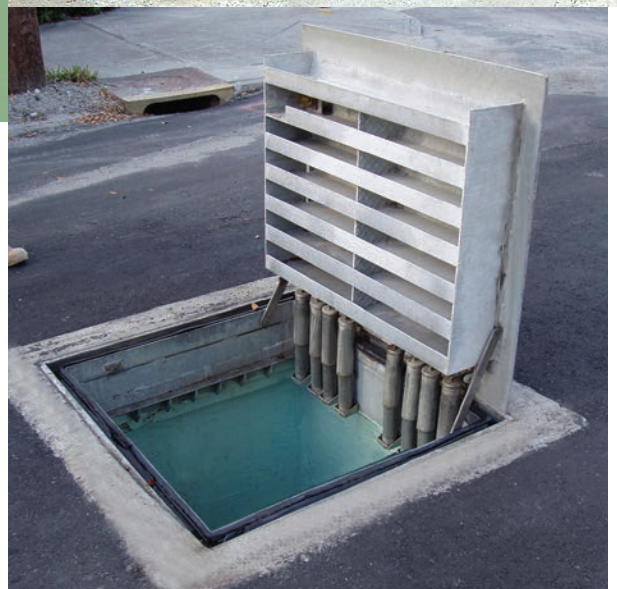

### Specialty Floor Access Doors

- Fire Rated
- Surface Mount
- High Load Capacity
- Precast Vault
- Transit System Emergency Evacuation Doors
- Special sizes for equipment access

*All BILCO floor access doors feature engineered lift assistance for easy, one-hand operation regardless of door size and weight.*

## Fire-Rated

Fire-rated floor doors maintain the fire rating of a 2-hour floor ceiling assembly where access is required between building floors. Fire rated floor doors feature an automatic closing system, fire resistant coating, and a pan cover designed to accept architectural flooring materials for concealed access.

### Features & Benefits

- Fire rated per NFPA 288, ASTM E119, UL 263, and IBC code requirements.
- Available in a variety of UL-listed sizes
- Accepts finished flooring up to 1/2" (12.5mm) in thickness
- Constructed with corrosion resistant materials to provide many years of trouble free, dependable service
- Available in a number of standard and custom sizes to satisfy any requirement

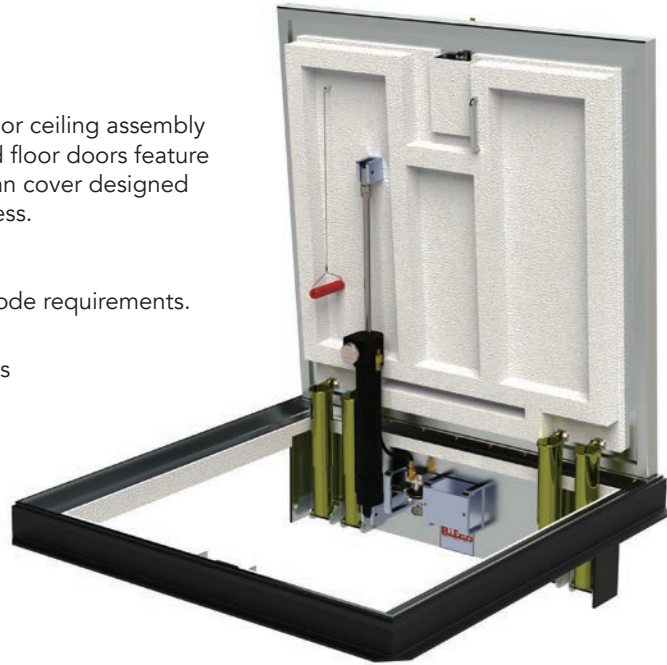

## High Load Capacity

Type HLC door is specially designed for extreme loading conditions generated by vehicles such as large aircraft, heavy equipment and forklift trucks. Doors are constructed of steel and covers are reinforced for a 200 psi + 30% impact live load.

## Flood Tight

Type FT-30 flood tight floor access doors are constructed for use in applications where there is concern of water or other liquids entering the access opening. Type FT-30 doors are rated to withstand a 30-foot (9.14m) head of water from the topside without leakage and up to a 5-foot (1.52m) head of water from the underside (when specified) and will resist low-pressure gases and odors. Doors are reinforced for AASHTO H-20 wheel loading and feature aluminum construction, type 316 stainless steel hardware, and engineered lift assistance for easy one-hand operation. (Patent Pending)







## SPECIAL APPLICATION DOORS

BILCO floor access doors utilize an engineered lift assistance design that is time tested and proven to ensure reliable operation and performance. Cover weights are calculated for all products and the required lift assistance is determined through engineering formulas to ensure easy and counter-balanced operation.



### Specialty Floor Access Doors

- Fire Rated
- Surface Mount
- High Load Capacity
- Precast Vault
- Transit System Emergency Evacuation Doors
- Special sizes for equipment access

*All BILCO floor access doors feature engineered lift assistance for easy, one-hand operation regardless of door size and weight.*





## Special Sizes

Type JD and JD-AL doors can be manufactured to virtually any size to meet your unique access requirements. Even extremely large doors, such as the one shown, are designed for easy operation by one person.



## Emergency Evacuation for Transit Systems

Type JD and JD-AL emergency evacuation doors are designed to provide egress from underground rapid transit system platforms and tunnels in emergency situations. Doors are designed with stainless steel panic hardware and compression spring operators for ease of operation. Other important features include H-20 reinforcing, handrails, custom signage and a slip-resistant cover finish.



## Precast Vault

Single and double leaf access doors incorporate features that reduce the amount of labor required to cast the door into a concrete vault. Doors feature aluminum construction and a lift assistance design that does not protrude below the frame. Frame skirts are available for easy casting into a concrete vault top slab



## Floor Access Doors

BILCO's floor access door safety products help workers do their job safely by protecting them while they are working. Products meet OSHA fall protection standards and make fixed ladder access safer and easier.



### Fall Protection Grating System Features

- Provides a permanent means of fall protection under access doors
- Exceeds OSHA fall protection requirements
- Aluminum grating with a safety-yellow powder coat paint finish for added durability
- Equipped with a stainless steel automatic hold-open device that securely locks the panel in the full open position
- Stainless steel hardware for corrosion resistance
- Supplied with a padlock hasp for added security
- Backed by a 25-year manufacturer's warranty

### LadderUP® Features

- Adjustable mounting hardware accommodates virtually any ladder rung size or spacing
- Telescoping design is spring balanced for ease of operation
- Automatically locks in the fully raised position to provide the user with a firm and steady hand-hold
- Handy release lever allows the post to be easily lowered to its retracted position
- Available in four levels of corrosion resistance to provide many years of trouble free, dependable service



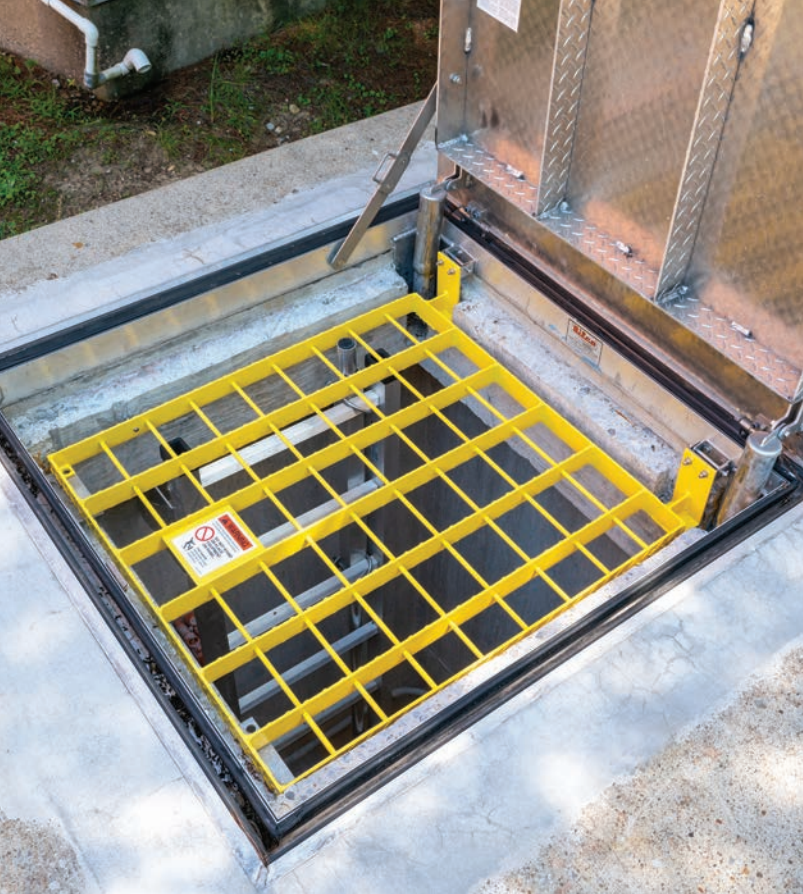

## Fall Protection Grating System

Fall Protection Grating System allows workers to safely inspect pumps and monitor underground areas. System permanently mounts under access door covers and are available as either factory-installed or as field-installable kits for all standard-sized BILCO Type J, JD, J-AL and J-DAL models. Grating system features aluminum construction with a safety yellow powder coat paint finish and stainless steel hardware.



## BILCO LadderUp® Safety Post

LadderUP® Safety Posts provide easier, safer ladder access through roof hatches, floor access doors and manholes. This telescoping post permanently mounts to the top two rungs of any fixed ladder, providing a positive hand-hold and enabling the user to enter or exit an opening in an upright and balanced position.

MODEL#	MATERIAL/FINISH	WEIGHT	
		LBS.	KG.
LU-1	Steel, yellow powder coat	24	11
LU-2	Steel, hot dip galvanized	24	11
LU-3	Type 304 Stainless Steel, sand blast finish	24	11
LU-4	Aluminum, mill finish	14	7





## FLOOR DOOR OPTIONS



Cylinder Lock

BILCO floor access doors can include any of the modifications shown below. In addition, BILCO's engineering department will custom design doors for your unique applications.

### Locking and Latching Devices

The following lock options are available to add security and prevent unauthorized access:

- Cylinder lock with a keyway protected by a threaded cover plug
- Recessed padlock hasp covered by a flush hinged lid
- Security cover plugs
- Interior or exterior padlock lugs
- Panic locks for emergency egress
- Detention locks for high security applications



Recessed Padlock Hasp

In addition to the options shown, BILCO's engineering department can custom design products to meet your security needs.

### Special Finishes

- Factory applied powder coat paint finish is available on all steel and aluminum products. Finish is available in four standard colors and custom colors can be specified
- Hot dipped galvanized finish (steel products only)
- Kynar® finish in custom colors (aluminum products only)
- Tnemec® finish in custom colors (steel and aluminum products)
- Clear anodized finish (aluminum products only)
- Custom finishes can also be specified



Security Cover Plugs

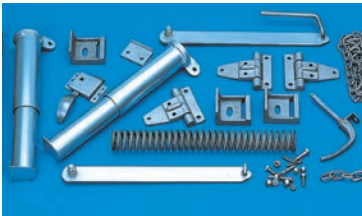

Stainless Steel Hardware

### Powder Coat Standard Colors



White



Yellow



Bronze



Black

### Stainless Steel Hardware

For installation in highly corrosive environments or when prolonged exposure to hot water or steam is anticipated, BILCO recommends stainless steel hardware. Standard Type 316 stainless steel hardware is featured on Type J-AL, JD-AL, J-AL H20 and JD-AL H20 doors. Other products can be supplied with stainless steel hardware upon request.



Special Finishes

### Other Options

- Steel or aluminum grating
- Submersible pump guide rail brackets
- Metal enclosed insulation
- Slip-resistant coatings
- Drop-in installation modifications
- Handrails
- Panic hardware
- Snow and ice melting cables
- Electric motor operation
- Fall protection grating
- Wireless security system for intrusion detection



Grating Panel Covers

## ADDITIONAL PRODUCTS



### Door Security Products

Barracuda door locking devices are designed to be installed in a matter of seconds in emergency situations to protect occupants against building intruders. Products are available for both inward and outward swinging doors and can be purchased on-line through our national distributors.

#### Features & Benefits

- Fast and simple to use; installs in a matter of seconds
- Less expensive than and more secure than small, inexpensive devices
- Free-standing device (not permanently attached to the door) that can be transferred between access points
- No maintenance or installation costs
- All steel construction with durable powder-coat paint finish



### Residential Products

#### BILCO Basement Doors

Basement doors are ideal for access to basement storage areas and for moving large items into finished basement areas. The wide opening allows storage items such as deck and patio furniture, and large items such as pool tables and large furniture, to be easily moved in and out of a basement. Doors meet building code requirements for emergency egress and are available in prime painted steel and high-density polyethylene construction.

#### Window Well Systems

Add natural daylight and ventilation to basement rooms, making them as warm and comfortable as any area in the home. Window Well Systems meet building code requirements for emergency egress and are constructed from non-corrosive materials for many years of maintenance-free service. Systems simply snap or slide together on site for easy installation and dome covers are available to protect the well opening.





The BILCO Company  
P.O. Box 1203  
New Haven, CT 06505  
Phone: 800.366.6530  
Fax: 203.535.1582

## Sales

United States: [commercial@BILCO.com](mailto:commercial@BILCO.com)  
International: [export@BILCO.com](mailto:export@BILCO.com)

Visit [BILCO.com](http://BILCO.com) to find your local sales representative

## BILCO.com

